

Stainless Steel Undermount Sink

Owner's Manual

Installation Instructions
and
Aftercare Information



Value For Life

www.castlebaysinks.com

Installer

Please leave this leaflet with the home owner/user, as it contains valuable after care advice.

Notes

Undermount sinks should only be installed to stone worktops by a specialist installer.

Square Strainer INSTALLATION

Insert the metal strainer with the rubber seal into the drain hole. Position the plastic bowl end the rubber gasket underneath the drain hole. Using a flat-head screw driver, turns the locking nut to tighten the metal strainer to the plastic bowl.

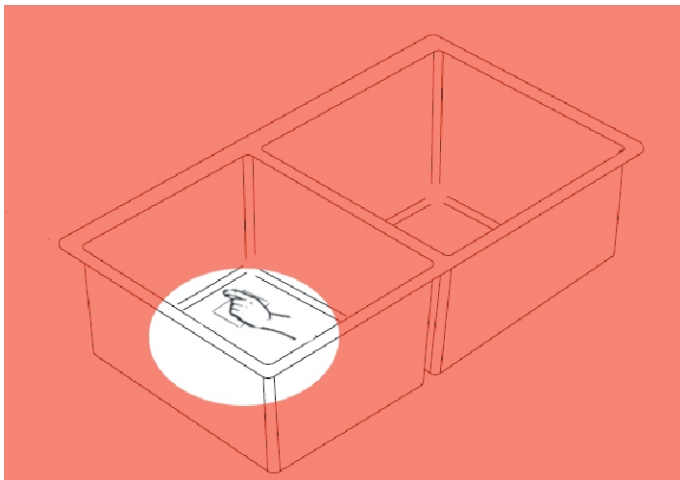
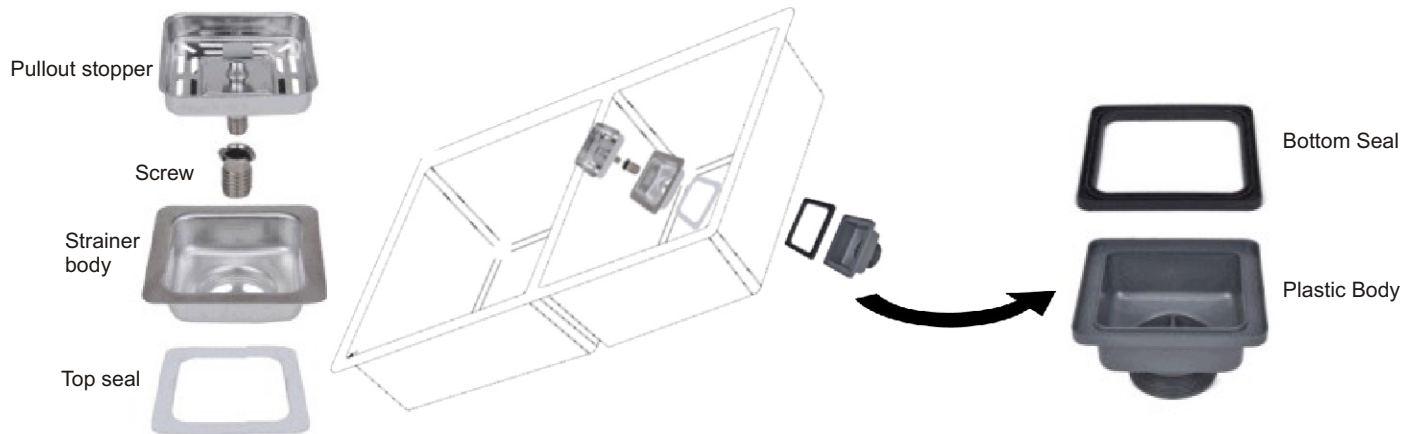

TIP

Have a partner lean over the sink and firmly press the strainer area **DOWN** while the other person tightens the tail piece underneath the sink.





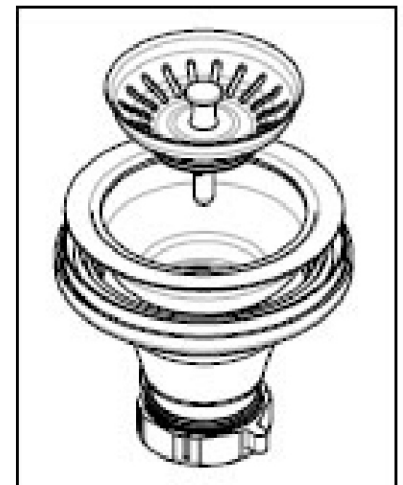
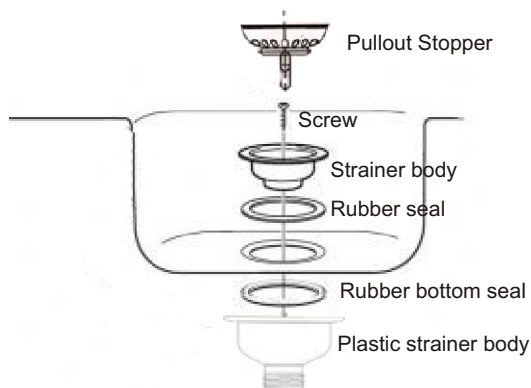









Connect tailpiece to strainer with slip nut.
(Apply glue if necessary)
Tighten to strainer while the other person pressing down from above.

















Round Strainer INSTALLATION



Sink Specification (All Models)

For specific model dimension diagram/specification, visit online at www.castlebaysinks.com.

 Lincoln 50/50 31" x 18" x 9"	 Lincoln 60/40 31" x 20" x 9"	 Lincoln Mini Plus 23" x 18" x 9"	 Evolution 50/50 30" x 18" x 8"	 Evolution 60/40 29" x 18" x 8"	 Evolution Mini Plus 20" x 18" x 8"
 Legendary 50/50 29" x 18" x 10"	 Legendary 60/40 29" x 18" x 10"	 Legendary Max Plus 28" x 18" x 10"	 Legendary Mini Plus 23" x 18" x 10"	 Legendary Bar 15" x 18" x 10"	Features: <ul style="list-style-type: none"> * 18 gauge premium stainless steel & satin finish * Sound-deadening insulation * Rear drain placement * Detailed handcrafted sinks * Superior workmanship * Some models with X-pattern grooves * Bowl depth from 8" to 10" depending on model * Radius corner from zero to R25 depending on model * Limited Lifetime Warranty Visit www.castlebaysinks.com for more info.
 London 50/50 29" x 18 3/4" x 9" Bowl Size: 13"	 London 60/40 33" x 18 3/4" x 9" Big Bowl Size: 17" Small Bowl Size: 13"	 Parkside Plus 29" x 18" x 9" Bowl Size: 15"			

 Pacific 50/50 33" x 18" x 10"	 Pacific 60/40 29" x 18" x 10"	 Pacific Max Plus 28" x 18" x 10"	 Pyke 50/50 30" x 17" x 8"	 Pyke 60/40 29 1/2" x 17" x 8"	 Pyke Mini Plus 21 3/4" x 17" x 8"
 Atlantic 50/50 / Atlantic U 32 29" x 18" x 9" / 32" x 18" x 9"	 Atlantic 60/40 29" x 18" x 9"	 Atlantic Max Plus 28" x 18" x 9"	 Atlantic Mini Plus 23" x 18" x 9"	 Atlantic Bar 15" x 18" x 9"	<h3>Trendsetter Series</h3>  <p>One-of-a-kind Square Strainer</p> <p>With commercial influences, the Trendsetter sinks offer one-of-a-kind square strainer style with flat bottom industrial design resulting in stunning good looks and offer a cutting edge contemporary style as well as unrivalled quality. The flat bottom surfaces maximizes bowl capacity for large kitchen items, and allows wineglasses or dishes to stand upright with less risk of tipping. Residual water may occur.</p>
 Solidary 50/50 29" x 18" x 10"	 Solidary 60/40 29" x 18" x 10"	 Solidary Max Plus 28" x 18" x 10"	 Solidary Mini Plus 23" x 18" x 10"	 Solidary Bar 15" x 18" x 10"	

While Castle Bay endeavors to provide accurate information, all dimensions are nominal, cannot be guaranteed, and are subject to change or cancellation. Castle Bay assumes no responsibility for use of superseded or voided specifications.

TEMPLATE INFORMATION

ATTENTION - PLEASE CONFIRM THAT THE TEMPLATE SUPPLIED CORRESPONDS TO THE SINK MODEL. The template is only be used as reference, and the actual sink should be present to ensure an accurate cut out. Castle Bay Sinks Inc assumes no liability for any damages incurred through its application.

CASTLE BAY SINKS INC RECOMMENDS THAT THE INSTALLATION OF A SINK IN AN UNDERMOUNT APPLICATION SHOULD BE PERFORMED BY AN EXPERIENCED PROFESSIONAL COUNTERTOP INSTALLER.



Limited Lifetime Warranty

Castle Bay Sinks (Canada) Inc. warrants its sink products to be free from manufacturing defects in materials and workmanship under normal usage to all purchasers. Should your sink prove defective for normal domestic purposes, Castle Bay Sinks will provide a replacement sink of an equivalent model free of charge, provided the sink you own had been installed and maintained in accordance with instructions provided by Castle Bay Sinks Inc..

Our warranty does not cover product failure caused by abusive treatment, misuse, improper care and cleaning, or damage due to handling or faulty installations.

Castle Bay Sinks will not be liable for any inconvenience or expense for material or labour related to removal or replacement of the defective sink; nor for any loss or damage to any person or property resulting from the defective sink.

Note that scratches, stains, chips are excluded from this warranty. For complete details of our warranty, visit www.castlebaysinks.com.

CONTACT US FIRST for Warranty Claims
Do not return to store without contacting us by email: warranty@castlebaysinks.com

Care & Maintenance

Castle Bay stainless steel sink is easy to keep clean. Simple everyday maintenance will ensure its long lasting beauty.

WHAT TO DO

For regular routine cleaning, use a non-abrasive cleaner. This will keep the sink free from residue and grease. The best form of maintenance is frequent, regular cleaning. Regularly rinse and towel dry your sink with a soft, dry cloth when not in use to keep it dry. This will prevent surface/mineral deposits and water spots caused by lime in the water.

WHAT NOT TO DO

Do not use common steel wool scouring pads or metal implements such as scrapers and wire brushes. These items can cause rust spots to appear on the sink. The rust is not from the stainless steel but from contamination by particles of carbon steel which have rubbed off the scouring pad or metal implement and have adhered to the surface of the sink.

SCRATCHES

Like many metallic surfaces, your stainless steel sink will scratch. Overtime, these scratches will blend into the overall finish of your sink and will become uniform with the sink's grain. For this same reason, a 10 years old sink may look less scratchy than the newly installed sink.

SURFACE RUST & STAINS

Stainless steel does not rust. Rust are a result of iron particles, from outside sources such as water, cookware, steel wool pads, etc, that eventually develop into rust spots. We recommend to use BAKING SODA mixed with vinegar to wipe off these spots.

WATER QUALITY

The quality of water can affect your sink's appearance. If your water has a high iron content, a brown surface stain can form on the sink giving the appearance of rust. Thus, we suggest that the sink be towel dried after each use, and be cleaned with a recommended cleanser.