

## Thank You For Choosing Castle Bay Sinks and Faucets Company

Castle Bay faucets reflect the true passion for stylish design and high quality craftsmanship. We are confident its dependability and beauty will satisfy you for years to come. Our products bring you comfort and value to your home at an affordable price. "Value for life" is our mission.

Please take a few minutes to review this guide. We reserve the right to make changes in product characteristics, packaging, or availability at any time without notice.



**TIPS FOR REMOVAL OF OLD FAUCET:** Always turn water supply OFF before removing existing faucet or disassembling the valve. Open faucet handle to relieve water pressure and ensure that complete water shut-off has been accomplished.



**TIPS FOR MAINTENANCE:** Your new faucet is designed for years of trouble-free performance. Avoid using abrasive cleaners, steel wool and harsh chemicals as these will dull the finish and void your warranty.

### CASTLE BAY LIFETIME LIMITED WARRANTY

Castle Bay Sinks warrants to the **original** consumer purchaser who purchases this faucet for use in his or her own home that this faucet will be free from defects in material and manufacturing workmanship, for as long as the consumer purchaser owns it.

Castle Bay Sinks will replace "free of charge", during the warranty period, any part that proves defective in material or workmanship under normal residential application.

THIS WARRANTY IS LIMITED TO REPLACEMENT PARTS ONLY AND DOES NOT COVER OR INCLUDE LABOR CHARGES OR DAMAGE INCURRED IN INSTALLATION, REPAIR OR REPLACEMENT OR ANY INCIDENTAL OR CONSEQUENTIAL DAMAGES WHATSOEVER, NOR DOES IT COVER OR INCLUDE DAMAGES FOR PERSONAL INJURY, PROPERTY DAMAGE OR ECONOMIC LOSS. In no event shall the liability of Castle Bay Sinks Inc. exceed the purchase price of the faucet.

Any damage to this faucet as a result of improper installation, misuse, accident, neglect or any use that violates the instructions furnished by us, **WILL VOID WARRANTY IMMEDIATELY**. This warranty is only valid to the original consumer purchaser and excludes industrial, commercial, or business use of the product.

Any claims must be made in writing, accompanied by the defective part along with the original proof of purchase (ie. original receipt) from the original consumer purchaser. All claims should be made initially by email to [sales@castlebaysinks.com](mailto:sales@castlebaysinks.com).



Bay  
Castle

Value For Life

## Panama (Pullout Kitchen Faucet)



## Panama Dimensions

### Flush the plumbing system before installing the faucets

Over time pipes can develop deposits of minerals and other debris in the pipes. In the case of remodeling, there can be other construction debris that can get caught in aerators and showerheads. It is very important to flush the pipes before installing the faucets. This is to avoid plumbing residues clogging the aerator, or possibly damaging the ceramic valves.

### MAINTENANCE

Your new faucet is designed for years of trouble-free performance. Keep it looking new by cleaning it periodically with a soft cloth. Avoid abrasive cleaners, steel wool and harsh chemicals as these will scratch, dull and/or damage the finish and/or product and void your warranty.

### TOOLS NEEDED

Adjustable wrench  
Groove joint pliers  
Plumber's putty  
Pipe tape  
Phillips and flat screwdrivers

### SAFETY TIPS

If you use soldering for the installation of the faucet, the seats cartridges and washers will have to be removed before using flame. Otherwise, warranty will be void on these parts  
Protect your eyes with safety glasses when cutting or soldering water supply line  
Cover your drain to avoid losing parts

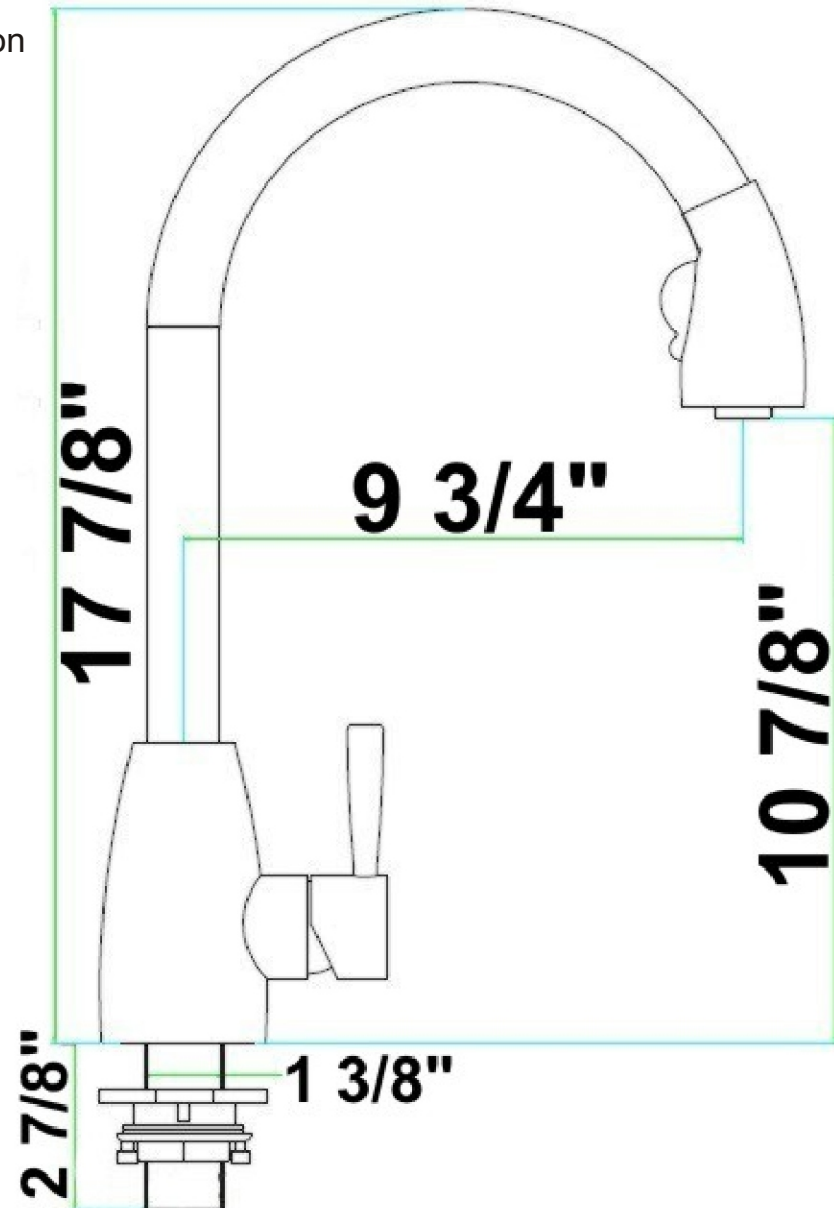

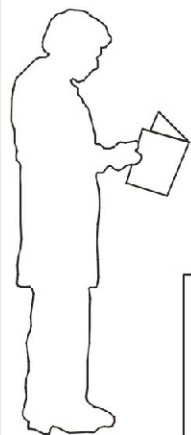

1

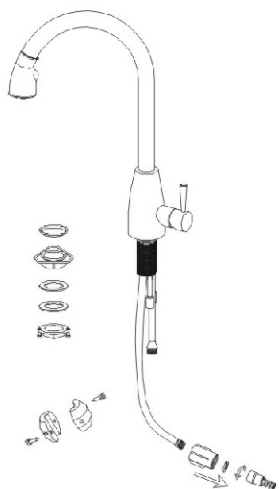

2

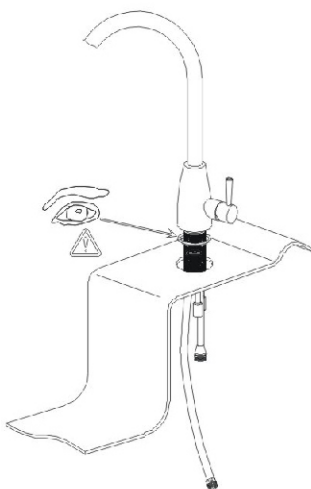

3

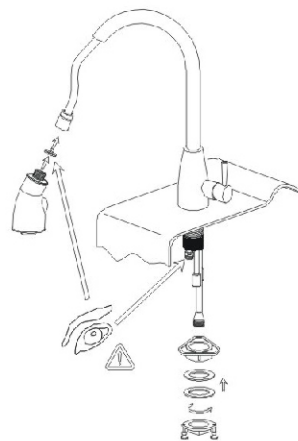

4

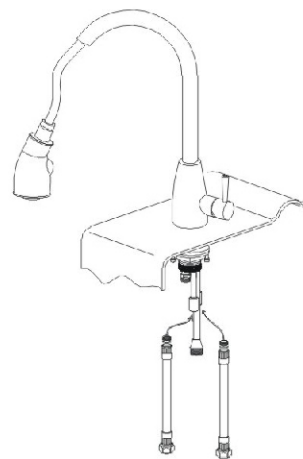

5

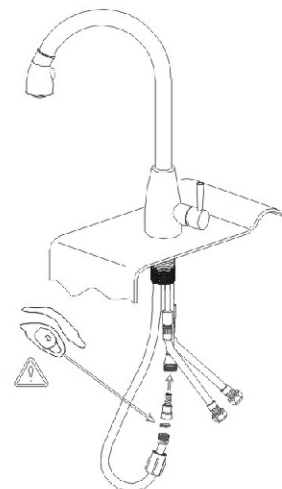

6

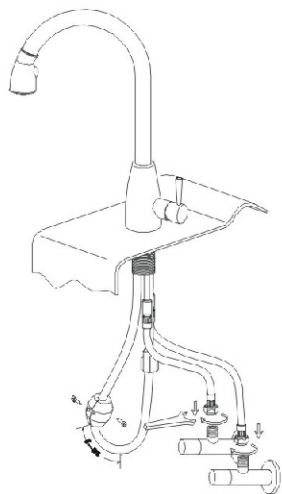

7

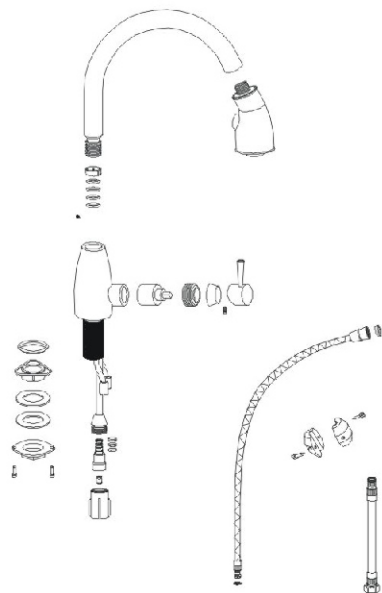

i

